

Notice for TAIYO YUDEN products

Please read this notice before using the TAIYO YUDEN products.

REMINDERS

- Product information in this catalog is as of October 2012. All of the contents specified herein are subject to change without notice due to technical improvements, etc. Therefore, please check for the latest information carefully before practical application or usage of the Products.

Please note that Taiyo Yuden Co., Ltd. shall not be responsible for any defects in products or equipment incorporating such products, which are caused under the conditions other than those specified in this catalog or individual specification.

- Please contact Taiyo Yuden Co., Ltd. for further details of product specifications as the individual specification is available.
- Please conduct validation and verification of products in actual condition of mounting and operating environment before commercial shipment of the equipment.
- All electronic components or functional modules listed in this catalog are developed, designed and intended for use in general electronics equipment.(for AV, office automation, household, office supply, information service, telecommunications, (such as mobile phone or PC) etc.). Before incorporating the components or devices into any equipment in the field such as transportation,(automotive control, train control, ship control), transportation signal, disaster prevention, medical, public information network (telephone exchange, base station) etc. which may have direct influence to harm or injure a human body, please contact Taiyo Yuden Co., Ltd. for more detail in advance. Do not incorporate the products into any equipment in fields such as aerospace, aviation, nuclear control, submarine system, military, etc. where higher safety and reliability are especially required.

In addition, even electronic components or functional modules that are used for the general electronic equipment, if the equipment or the electric circuit require high safety or reliability function or performances, a sufficient reliability evaluation check for safety shall be performed before commercial shipment and moreover, due consideration to install a protective circuit is strongly recommended at customer's design stage.

- The contents of this catalog are applicable to the products which are purchased from our sales offices or distributors (so called "TAIYO YUDEN' s official sales channel").
It is only applicable to the products purchased from any of TAIYO YUDEN' s official sales channel.
- Please note that Taiyo Yuden Co., Ltd. shall have no responsibility for any controversies or disputes that may occur in connection with a third party's intellectual property rights and other related rights arising from your usage of products in this catalog. Taiyo Yuden Co., Ltd. grants no license for such rights.

■ Caution for export

Certain items in this catalog may require specific procedures for export according to "Foreign Exchange and Foreign Trade Control Law" of Japan, "U.S. Export Administration Regulations", and other applicable regulations. Should you have any question or inquiry on this matter, please contact our sales staff.

SAW/FBAR DEVICES (FILTER / DUPLEXERS)



REFLOW

ORDERING CODE

(A) Previous Rule (applied to products registered on March 31, 2010 or before.)

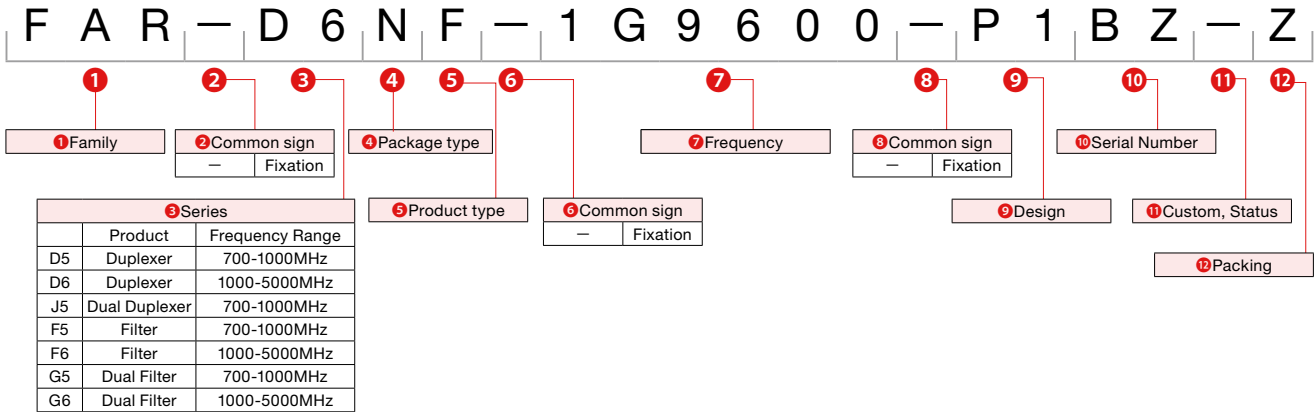

(B) New Rule (applied to products registered on April 1, 2010 or later.)

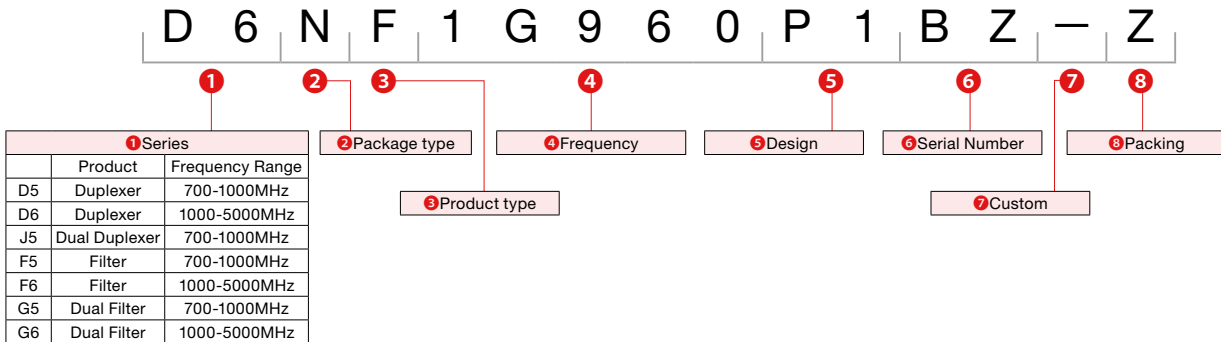

* For further details, please contact to TAIYO YUDEN Co.,Ltd.

EXTERNAL DIMENSIONS/STANDARD QUANTITY

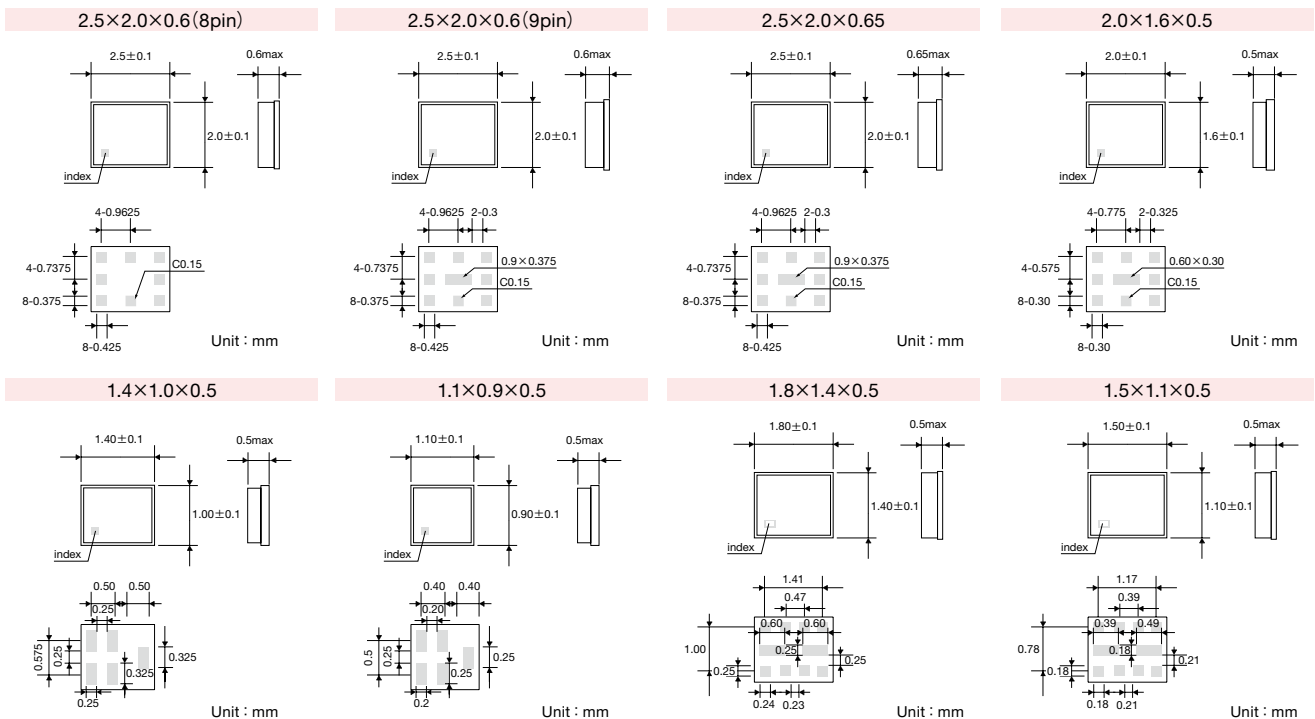

▶ This catalog contains the typical specification only due to the limitation of space. When you consider the purchase of our products, please check our specification. For details of each product (characteristics graph, reliability information, precautions for use, and so on), see our Web site (<http://www.ty-top.com/>).

PART NUMBERS

Duplexers

System	Part number	Package Size (mm)	Insertion Loss (dB)	Isolation (dB)	Remarks
W-CDMA I (2G)	FAR-D6JG-2G1400-D3FZ	2.5×2.0×0.65	1.4/1.7	54/47	9 Pin, B Type
	FAR-D6JH-2G1400-B1BT	2.5×2.0×0.65	1.4/1.7	58/48	9 Pin, B Type Rx : Bal.100ohm
CDMA/W-CDMA V (850)	FAR-D5NG-881M50-M11Z	2.5×2.0×0.6	1.45/1.8	66/52	9 Pin, B Type
	FAR-D5PF-881M50-M3E7	2.0×1.6×0.5	1.5/1.8	58/51	9 Pin, A Type
	FAR-D5NE-881M50-P1A9	2.5×2.0×0.6	1.6/1.8	57/51	9 Pin, B Type Rx : Bal.100ohm
	FAR-D5NE-881M50-P1A6Q	2.5×2.0×0.6	1.6/1.7	60/53	9 Pin, B Type 100ohm
	FAR-D5PE-881M50-P3EZ	2.0×1.6×0.5	1.4/1.7	59/52	9 Pin, B Type Rx : Bal.100ohm
	FAR-D5PE-881M50-P3EY	2.0×1.6×0.5	1.4/1.7	59/52	9 Pin, A Type Rx : Bal.100ohm
	D5NL881M5P1HY	3.0×2.5×0.7	1.6/2.6	60/51	SV-LTE Rx : Bal.100ohm
W-CDMA VIII (900)	FAR-D5NH-942M50-M1Y9	2.5×2.0×0.65	1.8/2.3	58/50	9 Pin, B Type
	FAR-D5NF-942M50-P1GZ	2.5×2.0×0.65	1.9/2.3	58/50	9 Pin, B Type Rx : Bal.100ohm
	FAR-D5NF-942M50-P1GWQ	2.5×2.0×0.65	1.9/2.3	59/54	9 Pin, B Type Rx : Bal.100ohm, GPS High Att.
	D5PF942M5M3G9	2.0×1.6×0.5	1.9/2.2	60/52	9 Pin, B Type
	D5PE942M5P3GT	2.0×1.6×0.5	1.7/2.2	58/54	9 Pin, B Type Rx : Bal.100ohm
PCS/W-CDMA II (1.9G)	FAR-D6NH-1G9600-M1Z9	2.5×2.0×0.65	2.2/3.1	55/50	9 Pin, B Type
	FAR-D6NH-1G9600-M1Z6	2.5×2.0×0.65	2.3/2.7	55/53	9 Pin, B Type Low Rx IL
	D6HK1G960DK12	2.5×2.0×0.65	2.0/2.3	58/52	9 Pin, B Type
	FAR-D6NF-1G9600-P1BT	2.5×2.0×0.65	2.5/2.8	54/55	9 Pin, B Type Rx : Bal.100ohm, Low Rx IL
	D6NF1G960P1BR	2.5×2.0×0.65	2.5/3.4	56/53	9 Pin, B Type Rx : Bal.100ohm High GPS Att. & Rx Isol.
W-CDMA IV (DCS/2G)	D6HH1G960BH95	2.5×2.0×0.65	2.3/2.5	56/53	9 Pin, B Type Rx : Bal.100ohm
	FAR-D6JH-2G1325-B1YZ	2.5×2.0×0.65	1.5/1.7	57/51	9 Pin, B Type Rx : Bal.100ohm
LTE XIII	D6JG2G132D3GZ	2.5×2.0×0.65	1.6/1.9	53/52	9 Pin, B Type Rx : Bal.100ohm
LTE XVII	D5NL782M0P1JZ	3.0×2.5×0.7	1.9/2.2	66/52	SV-LTE
CDMA BC0+BC10	FAR-D5NE-740M00-P1C9	2.5×2.0×0.6	1.7/2.0	61/58	9 Pin, B Type Rx : Bal.100ohm
	D5NF878M0P1ET	2.5×2.0×0.65	1.9/2.5	58/50	9 Pin, B Type Rx : Bal.100ohm

CDMA/GSM850/Band V

System	Part number	Package Size (mm)	Insertion Loss (dB)	Attenuation (dB)	Remarks
CDMA Tx	FAR-F5KB-836M50-B4ER	1.4×1.0×0.5	1.7	44	100ohm input
	FAR-F5KB-836M50-B4EG	1.4×1.0×0.5	1.6	42	200ohm input
	F5QA836M5M2AR	1.1×0.9×0.5	1.9	45	High Att.
CDMA/GSM850 Tx	FAR-F5KA-836M50-D4DF	1.4×1.0×0.5	1.9	44	High Att.
CDMA Rx	FAR-F5KB-881M50-B4ED	1.4×1.0×0.5	1.5	61	100ohm output
	FAR-F5KY-881M50-B4UZ	1.4×1.0×0.5	1.5	61	100ohm output, High Att.
	FAR-F5KB-881M50-B4EJ	1.4×1.0×0.5	1.4	64	200ohm output
	F5QG881M5P2KG	1.1×0.9×0.5	1.5	56	100ohm output, High Att., Low Loss
GSM850/CDMA Rx	FAR-F5KA-881M50-D4DB	1.4×1.0×0.5	1.7	56	High Att.
	FAR-F5QA-881M50-M2AF	1.1×0.9×0.5	1.6	46	—
GSM850 Rx	FAR-F5KB-881M50-B4EA	1.4×1.0×0.5	1.7	53	150ohm output
	FAR-F5QB-881M50-P2BA	1.1×0.9×0.5	1.3	63	150ohm output

CDMA2000 BC0+BC10

System	Part number	Package Size (mm)	Insertion Loss (dB)	Attenuation (dB)	Remarks
CDMA2000 BC0+10 Tx	F5KA833M0D4MG	1.4×1.0×0.5	1.4	20	Low IL
CDMA2000 BC0+10 Rx	F5KY878M0B4ND	1.4×1.0×0.5	2.1	53	100ohm output

GSM/EGSM/Band VIII

System	Part number	Package Size (mm)	Insertion Loss (dB)	Attenuation (dB)	Remarks
EGSM Tx	FAR-F5KA-897M50-D4DC	1.4×1.0×0.5	2.2	16	High Att.
	FAR-F5KA-897M50-D4VW	1.4×1.0×0.5	2.6	38	High Att.
	F5QA879M5M2AC	1.1×0.9×0.5	2.3	18	—
EGSM Rx	FAR-F5KB-942M50-B4ES	1.4×1.0×0.5	2.4	29	100ohm output
	FAR-F5KY-942M50-B4UW	1.4×1.0×0.5	2.0	57	100ohm output, High Att.
	FAR-F5KA-942M50-D4DD	1.4×1.0×0.5	2.0	34	High Att.
	FAR-F5KB-942M50-B4EB	1.4×1.0×0.5	1.6	26	150ohm output
	FAR-F5QB-942M50-P2BB	1.1×0.9×0.5	1.6	28	150ohm output
	F5KA942M5D4MYB	1.4×1.0×0.5	1.9	53	High Att.
	F5QG942M5P2KB	1.1×0.9×0.5	2.2	56	100ohm output, High Att.

DCS/Band III

System	Part number	Package Size (mm)	Insertion Loss (dB)	Attenuation (dB)	Remarks
DCS Tx	FAR-F6KA-1G7475-D4CY	1.4×1.0×0.5	2.5	30	
	FAR-F6KA-1G8425-D4CK	1.4×1.0×0.5	2.1	20	
DCS Rx	FAR-F6KB-1G8425-B4GA	1.4×1.0×0.5	1.5	14	150ohm output
	F6QB1G842P2BM	1.1×0.9×0.5	1.8	15	100ohm output

PCS/GSM1900/Band II

System	Part number	Package Size (mm)	Insertion Loss (dB)	Attenuation (dB)	Remarks
US-PCS Tx	FAR-F6KA-1G8800-L4AF	1.4×1.0×0.5	2.4	35	High Att.
	FAR-F6KB-1G8800-B4GS	1.4×1.0×0.5	2.3	28	100ohm input
US-PCS Rx	FAR-F6KA-1G9600-D4DQ	1.4×1.0×0.5	3.4	44	High Att.
	FAR-F6KA-1G9600-D4MT	1.4×1.0×0.5	3.4	43	High Att.
	FAR-F6KB-1G9600-B4GP	1.4×1.0×0.5	2.1	23	100ohm output
	F6KY1G960B4NF	1.4×1.0×0.5	2.8	50	100ohm output
GSM1900/US-PCS Rx	FAR-F6KA-1G9600-D4CR	1.4×1.0×0.5	2.0	18	
GSM1900 Rx	FAR-F6KB-1G9600-B4GB	1.4×1.0×0.5	1.6	18	150ohm output

► This catalog contains the typical specification only due to the limitation of space. When you consider the purchase of our products, please check our specification. For details of each product (characteristics graph, reliability information, precautions for use, and so on), see our Web site (<http://www.ty-top.com/>).

PART NUMBERS

GSM Dual

System	Part number	Package Size (mm)	Insertion Loss (dB)	Attenuation (dB)	Remarks
EGSM+DCS Rx	FAR-G6KZ-1G8425-Y4WZ	1.8×1.4×0.5	1.8/1.6	31/16	EGSM 150ohm output DCS 150ohm output
DCS+EGSM Rx	FAR-G6KZ-1G8425-Y4WY	1.8×1.4×0.5	1.6/1.8	16/31	DCS 150ohm output EGSM 150ohm output
GSM850+EGSM Rx	FAR-G5QC-942M50-N2FB	1.5×1.1×0.5	1.5/1.8	50/29	GSM850 150ohm output EGSM 150ohm output
GSM850+EGSM Rx (Common Input)	FAR-G5KT-942M50-Y4RW	1.8×1.4×0.5	1.9/2.2	50/25	GSM850 150ohm output EGSM 150ohm output
GSM850+EGSM Rx (Common Output)	FAR-G5KW-942M50-Y4YD	1.8×1.4×0.5	2.5/1.8	32/38	EGSM 150ohm output GSM850 150ohm output
EGSM+GSM850 Rx	FAR-G5KC-942M50-Y4YW	1.8×1.4×0.5	1.8/1.4	31/54	EGSM 150ohm output GSM850 150ohm output
	FAR-G5QC-942M50-N2CD	1.5×1.1×0.5	1.7/1.4	29/51	EGSM 150ohm output GSM850 150ohm output
EGSM+GSM850 Rx (Common Input)	FAR-G5KT-942M50-Y4RZ	1.8×1.4×0.5	2.2/1.9	25/52	EGSM 150ohm output GSM850 150ohm output
	FAR-G5QD-942M50-N2DB	1.5×1.1×0.5	2.5/2.0	25/55	EGSM 150ohm output GSM850 150ohm output
DCS+GSM1900 Rx	FAR-G6GQ-1G9600-N2FA	1.5×1.1×0.5	1.9/1.7	17/13	DCS 150ohm output GSM1900 150ohm output
	G6QJ1G960M2MB	1.5×1.1×0.5	1.9/1.9	19/19	Rx Dual Unbal
DCS+GSM1900 Rx (Common Input)	FAR-G6KT-1G9600-Y4RU	1.8×1.4×0.5	1.9/1.8	13/18	GSM1900 150ohm output DCS 150ohm output
GSM1900+DCS Rx	FAR-G6KC-1G9600-Y4YY	1.8×1.4×0.5	1.9/1.6	14/16	GSM1900 150ohm output DCS 150ohm output
	G6QC1G960N2CH	1.5×1.1×0.5	1.6/1.2	13/15	GSM1900 150ohm output DCS 150ohm output
GSM1900+DCS Rx (Common Input)	FAR-G6KT-1G9600-Y4RY	1.8×1.4×0.5	1.9/1.8	13/18	GSM1900 150ohm output DCS 150ohm output
GSM1900+DCS Rx (Common Output)	FAR-G6KW-1G9600-Y4YC	1.8×1.4×0.5	2.2/3.1	13/15	GSM1900 170ohm output DCS 170ohm output
	G6QE1G960N2EC	1.5×1.1×0.5	2.5/2.5	18/13	GSM1900 150ohm output DCS 150ohm output
	G6QE1G960N2EE	1.5×1.1×0.5	2.2/2.2	31/14	GSM1900/DCS 150ohm output Low Loss
GSM1900+850 Rx	G6QF1G960N2GA	1.5×1.1×0.5	1.6/1.4	14/54	GSM1900 150ohm output GSM850 150ohm output

GPS

System	Part number	Package Size (mm)	Insertion Loss (dB)	Attenuation (dB)	Remarks
GPS	FAR-F6KA-1G5754-L4AA	1.4×1.0×0.5	0.9	—	Low loss
	FAR-F6KA-1G5754-L4AJ	1.4×1.0×0.5	0.9	—	Low loss, High Att.
	FAR-F6KA-1G5754-L4AB	1.4×1.0×0.5	0.44	—	Ultra Low loss
	FAR-F6QA-1G5754-H2JD	1.1×0.9×0.5	0.87	—	Low loss
	FAR-F6QA-1G5754-H2JE	1.1×0.9×0.5	1.27	—	High Att.
	F6QA1G575H2JF	1.1×0.9×0.5	0.96	—	Low loss, High Att.
	FAR-F6KB-1G5754-B4GE	1.4×1.0×0.5	1.1	—	100ohm output, Low loss
	FAR-F6KB-1G5754-B4GU	1.4×1.0×0.5	1.2	—	100ohm output, High Att.
GPS/GNSS	FAR-F6KA-1G5859-D4MS	1.4×1.0×0.5	1.0/1.2	—	—
	FAR-F6KB-1G5859-B4HR	1.4×1.0×0.5	1.1/1.4	—	100ohm output

W-CDMA

System	Part number	Package Size (mm)	Insertion Loss (dB)	Attenuation (dB)	Remarks
W-CDMA I (2G) Tx	FAR-F6KA-1G9500-D4DG	1.4×1.0×0.5	1.6	38	Low loss, High Att.
	FAR-F6KB-1G9500-B4GJ	1.4×1.0×0.5	2.1	34	100ohm input
	F6QA1G950M2AA	1.1×0.9×0.5	1.8	38	Low loss, High Att.
W-CDMA I (2G) Rx	FAR-F6KA-2G1400-D4CG	1.4×1.0×0.5	1.9	39	
	FAR-F6KA-2G1400-D4DW	1.4×1.0×0.5	1.9	48	High Att.
	FAR-F6KB-2G1400-B4GC	1.4×1.0×0.5	1.7	39	100ohm output
	FAR-F6KY-2G1400-B4UY	1.4×1.0×0.5	1.8	64	100ohm output, High Att.
	F6QG2G140P2KA	1.1×0.9×0.5	1.7	55	100ohm output, High Att.
W-CDMA I(2G)+II(1900) Rx	G6QL2G140M2PA	1.5×1.1×0.5	1.9/3.0	48/41	
W-CDMA I (2G)+V (850) Rx	FAR-G6GK-2G1400-Y4SH	1.8×1.4×0.5	1.6/1.5	42/64	I (2G) 200ohm output V (850) 200ohm output
W-CDMA V (850)+VIII (900) Rx	G5QH942M5N2LN	1.5×1.1×0.5	1.6/20	56/50	100ohm output
W-CDMA VIII + V Rx (Common Output)	G5QT942M5N2VA	1.5×1.1×0.5	2.3/2.0	48/48	100ohm output
J-CDMA (2G/B.W.20MHz) Rx	FAR-F6KB-2G1200-B4GQ	1.4×1.0×0.5	1.4	48	100ohm output
W-CDMA IV (1.7G/2G) Tx	FAR-F6KA-1G7400-D4DE	1.4×1.0×0.5	1.5	44	
W-CDMA VII Tx	F6KA2G535L4AM	1.4×1.0×0.5	1.6	30	
W-CDMA/LTE VII Rx	FAR-F6KY-2G6550-B4UN	1.4×1.0×0.5	2.8	54	100ohm output, High Att.
W-CDMA IX (1.7G) Tx	FAR-F6KA-1G7675-D4CT	1.4×1.0×0.5	1.8	31	
W-CDMA IX (1.7G) Rx	FAR-F6KB-1G8625-B4GT	1.4×1.0×0.5	2.1	40	100ohm output
LTE XIII Tx	FAR-F5KA-782M00-D4VP	1.4×1.0×0.5	1.5	55	
LTE XIII Rx	FAR-F5KY-751M00-B4UQ	1.4×1.0×0.5	1.6	50	100ohm output
LTE XVII Tx	FAR-F5KA-710M00-D4VQ	1.4×1.0×0.5	1.2	32	
LTE XVII Rx	FAR-F5KY-740M00-B4UR	1.4×1.0×0.5	1.4	60	100ohm output
LTE XX	F5KA847M0D4ML	1.4×1.0×0.5	1.7	52	
TD LTE 38 Rx	F6KB2G595B4HS	1.4×1.0×0.5	2.6	—	150ohm output
TD LTE 40 Rx	F6KB2G350B4HT	1.4×1.0×0.5	2.7	—	150ohm output

Other

System	Part number	Package Size (mm)	Insertion Loss (dB)	Attenuation (dB)	Remarks
ISM900 (B.W.26MHz)	FAR-F5QA-915M00-M2AK	1.1×0.9×0.5	1.8	—	
TD-SCDMA/TD-LTE34	FAR-F6KA-2G0175-D4DR	1.4×1.0×0.5	1.8	—	High Att
	FAR-F6KA-1G9000-D4DS	1.4×1.0×0.5	1.6	—	
TD-SCDMA+34(2G)+39(1.9G)	G6QJ2G017M2MD	1.5×1.1×0.5	1.3/1.4	—	2 IN/2 OUT
	G6QJ2G017M2RD	1.5×1.1×0.5	1.6/2.0	—	1 IN/2 OUT
Wireless LAN	FAR-F6KA-2G4418-D4CU	1.4×1.0×0.5	2.6	—	+10dBm
	FAR-F6KA-2G4418-A4VA	1.4×1.0×0.5	3.0	—	+23dBm
	FAR-F6KA-2G4500-A4VD	1.4×1.0×0.5	1.9	—	Low IL,+19dBm
	F6KA2G436A4VE	1.4×1.0×0.5	2.5	—	BW=72MHz,+24dBm
	F6KA2G466A4VJ	1.4×1.0×0.5	2.8	—	BW=68MHz,+24dBm

► This catalog contains the typical specification only due to the limitation of space. When you consider the purchase of our products, please check our specification. For details of each product (characteristics graph, reliability information, precautions for use, and so on), see our Web site (<http://www.ty-top.com/>).

SAW/FBAR DEVICES (FILTER / DUPLEXERS)

PACKAGING

① Minimum Quantity

Type	Size (mm)	Code & Quantity (Pieces)							
Duplexer	3.0 × 2.5	Z	3000			U	10000		
	2.5 × 2.0	Z	3000			U	10000		
	2.0 × 1.6	Z	3000					Y	15000
Single Filter	2.0 × 1.6	Z	3000					Y	15000
	1.4 × 1.0	Z	3000					Y	15000
	1.1 × 0.9			J	5000			Y	15000
Dual Filter	2.0 × 1.6	Z	3000					Y	15000
	1.8 × 1.4	Z	3000					Y	15000
	1.5 × 1.1			J	5000			Y	15000

② Tape material

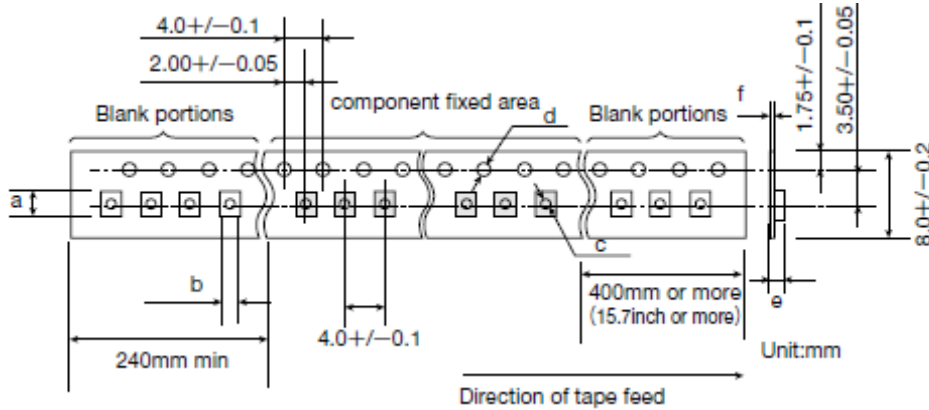

● Taping dimensions

Type	Size (mm)	a	b	c	d	e	f
Duplexer	3.0 × 2.5	3.4 ± 0.1	2.85 ± 0.1	1.05 ± 0.5	1.55 ± 0.05	1.0 ± 0.1	0.25 ± 0.05
	2.5 × 2.0	2.8 ± 0.1	2.3 ± 0.1	1.5 + 0.1 / - 0	1.5 + 0.1 / - 0	1.0 + 0.1 / - 0.0	0.25 ± 0.05
	2.0 × 1.6	2.4 ± 0.1	2.0 ± 0.1	1.05 ± 0.05	1.5 + 0.1 / - 0	0.90 - 0.05	0.25 ± 0.05
Single Filter	2.0 × 1.6	2.4 ± 0.1	2.0 ± 0.1	1.05 ± 0.05	1.5 + 0.1 / - 0	0.90 - 0.05	0.25 ± 0.05
	1.4 × 1.0	1.7 ± 0.1	1.3 ± 0.1	0.5 ± 0.05	1.5 + 0.1 / - 0	0.63 ± 0.05	0.20 ± 0.05
	1.1 × 0.9	1.3 ± 0.1	1.1 ± 0.1	0.5 ± 0.05	1.55 ± 0.05	0.63 ± 0.05	0.20 ± 0.05
Dual Filter	2.0 × 1.6	2.4 ± 0.1	2.0	1.05 ± 0.05	1.5 + 0.1 / - 0	0.90 - 0.05	0.25 ± 0.05
	1.8 × 1.4	2.2 ± 0.1	1.8	0.5 ± 0.05	1.55 ± 0.05	0.8 ± 0.1	0.30 ± 0.05
	1.5 × 1.1	1.8 ± 0.1	1.4	0.5 ± 0.05	1.5 + 0.1 / - 0	0.7 ± 0.1	0.25 ± 0.05

Unit: mm

● Material of Tape (Conductive)

Tape : Polystyrene

Top cover tape : Polyethylene terephthalate (PET) and Polyethylene

③ Top Tape Strength

The top tape requires a peel-off force of 0.1 to 1.0N in the direction of the arrow as illustrated below.

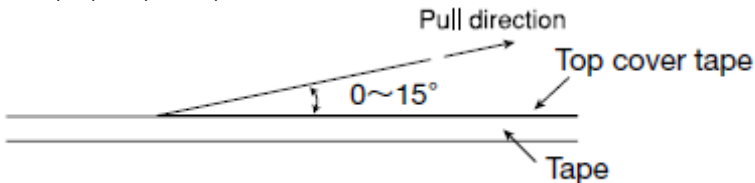

④ Reel size

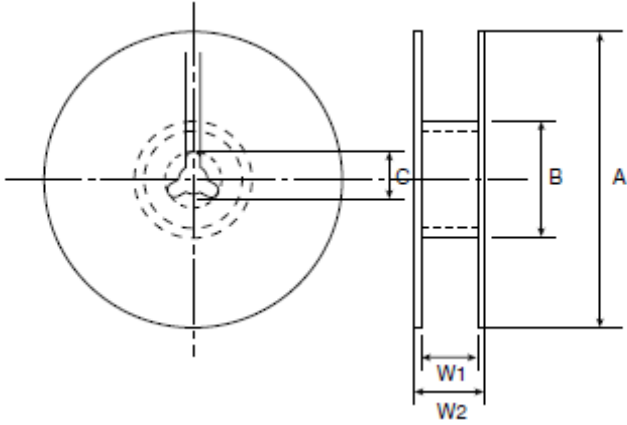

● Material of Reel

Material : Polystyrene + Carbon

Characteristics : Conform to EIAJ-ET-7200A

Color : Black

Surface resistance (reference value) : 109 Ω /sq Max.

Code	Quantity	A	B	C	W1	W2
Z	3,000 pcs	φ 180.0 +0.0/-1.5	φ 66.0 ±0.5	φ 13.0 ±0.2	9.0 +1.0/-0.0	11.4 ±1.0
J	5,000 pcs	φ 180.0 +0.0/-1.5	φ 66.0 ±0.5	φ 13.0 ±0.2	9.0 +1.0/-0.0	11.4 ±1.0
U	10,000 pcs	φ 330.0 ±2.0	φ 100.0 ±1.0	φ 13.0 ±0.2	9.4 ±1.0	13.4 ±1.0
Y	15,000 pcs	φ 330.0 ±2.0	φ 100.0 ±1.0	φ 13.0 ±0.2	9.4 ±1.0	13.4 ±1.0

Unit : mm

⑤ Reel label and Reel C-Label sticking and Winding method

● Surface

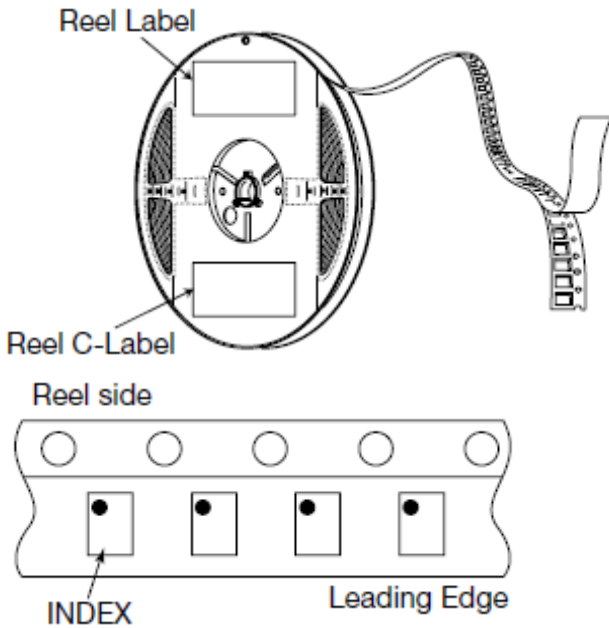

Filter

RELIABILITY DATA

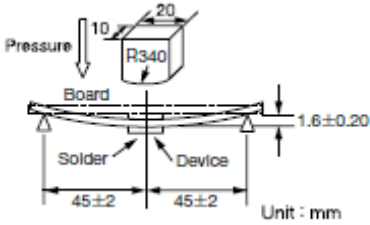
1. Terminal strength	
Specified Value	No damage to be found.
Test Methods and Remarks	Bending Test. according to IEC60068-2-21(JISC60068-2-21) 
2. Mechanical shock	
Specified Value	After testing, meet the specified characteristics at a room temperature.
Test Methods and Remarks	Apply 14700m/s ² for 0.5ms 5 times for each of 6 directions. according to IEC68-2-27(JISC60068-2-27).
3. Vibration	
Specified Value	After testing, meet the specified characteristics at a room temperature.
Test Methods and Remarks	With 1.5 mm of whole amplitude at 10 to 55 Hz of frequency, and 98m/s ² of acceleration at 55 to 500Hz, apply a vibration for 2 hours for each of 3 directions, period is 15 minutes(10 to 500 to 10Hz)
4. Drop 1	
Specified Value	After testing, meet the specified characteristics at a room temperature.
Test Methods and Remarks	Drop 3 times onto concrete floor from the height of 1.0m.
5. Drop 2	
Specified Value	After testing, meet the specified characteristics at a room temperature.
Test Methods and Remarks	Drop with 150g weight 3 times in each 6 direction onto concrete floor from the height of 1.8m.
6. Temperature cycling	
Specified Value	After testing, meet the specified characteristics at a room temperature.
Test Methods and Remarks	Temp. range -40 to +100°C. 500cycle.
7. Static humidity	
Specified Value	After testing, meet the specified characteristics at a room temperature.
Test Methods and Remarks	+85°C, 90% to 95%RH, apply DC5V, 1000hours.
8. High temperature storage life	
Specified Value	After testing, meet the specified characteristics at a room temperature.
Test Methods and Remarks	+100°C, 1000hours.
9. Low temperature storage life	
Specified Value	After testing, meet the specified characteristics at a room temperature.
Test Methods and Remarks	-40°C, 1000hours.

▶ This catalog contains the typical specification only due to the limitation of space. When you consider the purchase of our products, please check our specification.
For details of each product (characteristics graph, reliability information, precautions for use, and so on), see our Web site (<http://www.ty-top.com/>).

10. Solderability 1

Specified Value	More than 90% of area of terminals to be covered with the solder. A change of the remarkable appearance do not have it.
Test Methods and Remarks	Lead-free Solder paste, Reflow; Peak temperature 245°C

11. Solderability 2

Specified Value	More than 90% of area of terminals to be covered with the solder. A change of the remarkable appearance do not have it.
Test Methods and Remarks	Sn-Pb Solder paste, Reflow; Peak temperature 235°C

12. Solder heat resistance

Specified Value	After testing, meet the specified characteristics at a room temperature. A change of the remarkable appearance do not have it.
Test Methods and Remarks	<p>◆Recommended temperature profile of reflow soldering Figure shows recommended temperature profile of reflow soldering in the case of lead-free solder alloy Sn3.0Ag0.5Cu. Suitable condition for solder heating is differed depending on composition and manufacturing method. Please contact to solder manufacturer for the details.</p> <p>Temperature (°C)</p> <p>Ambient temperature rise slope : 1~4°C/sec.</p> <p>Pre-Heating 150~180°C</p> <p>30~50sec.</p> <p>Temperature in heat condition : 230°C min. 50sec. max. Temperature of upper surface of package and PCB surface : 260°C min. 10sec. max.</p> <p>Ambient temperature cool slope : 1~4°C/sec.</p> <p>50~110sec. 10sec.</p>

► This catalog contains the typical specification only due to the limitation of space. When you consider the purchase of our products, please check our specification.
For details of each product (characteristics graph, reliability information, precautions for use, and so on), see our Web site (<http://www.ty-top.com/>).

Duplexer

RELIABILITY DATA

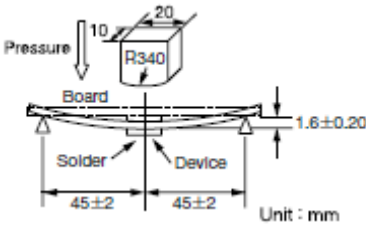
1. Terminal strength	
Specified Value	No damage to be found.
Test Methods and Remarks	<p>Bend width 4mm, hold for 5 ± 1 sec. according to IEC60068-2-21(JISC60068-2-21)</p>  <p>Unit : mm</p>
2. Mechanical shock	
Specified Value	After testing, meet the specified characteristics at a room temperature.
Test Methods and Remarks	Apply 14700m/s^2 for 0.5ms 5 times for each of 6 directions. according to IEC68-2-27(JISC60068-2-27).
3. Vibration	
Specified Value	After testing, meet the specified characteristics at a room temperature.
Test Methods and Remarks	With 1.5 mm of whole amplitude at 10 to 55 Hz of frequency, and 98m/s^2 of acceleration at 55 to 500Hz, apply a vibration for 2 hours for each of 3 directions, period is 15 minutes(10 to 500 to 10Hz)
4. Drop 1	
Specified Value	After testing, meet the specified characteristics at a room temperature.
Test Methods and Remarks	Drop 3 times onto concrete floor from the height of 1.0m.
5. Drop 2	
Specified Value	After testing, meet the specified characteristics at a room temperature.
Test Methods and Remarks	Drop with 150g weight 3 times in each 6 direction onto concrete floor from the height of 1.8m.
6. Temperature cycling	
Specified Value	After testing, meet the specified characteristics at a room temperature.
Test Methods and Remarks	Temp. range -40 to $+100^\circ\text{C}$. 500cycle.
7. Static humidity	
Specified Value	After testing, meet the specified characteristics at a room temperature.
Test Methods and Remarks	$+85^\circ\text{C}$, 90% to 95%RH, apply DC5V, 1000hours.
8. High temperature storage life	
Specified Value	After testing, meet the specified characteristics at a room temperature.
Test Methods and Remarks	$+100^\circ\text{C}$, 1000hours.
9. Low temperature storage life	
Specified Value	After testing, meet the specified characteristics at a room temperature.
Test Methods and Remarks	-40°C , 1000hours.

▶ This catalog contains the typical specification only due to the limitation of space. When you consider the purchase of our products, please check our specification. For details of each product (characteristics graph, reliability information, precautions for use, and so on), see our Web site (<http://www.ty-top.com/>).

10. High Temperature Bias	
Specified Value	After testing, meet the specified characteristics at a room temperature.
Test Methods and Remarks	+50°C, +29dBm, 50000hours.
11. Solderbility 1	
Specified Value	More than 90% of area of terminals to be covered with the solder. A change of the remarkable appearance do not have it.
Test Methods and Remarks	Lead-free Solder paste, Reflow; Peak temperature 245°C
12. Solderbility 2	
Specified Value	More than 90% of area of terminals to be covered with the solder. A change of the remarkable appearance do not have it.
Test Methods and Remarks	Sn-Pb Solder paste, Reflow; Peak temperature 235°C
13. Solder heat resistance	
Specified Value	After testing, meet the specified characteristics at a room temperature. A change of the remarkable appearance do not have it.
Test Methods and Remarks	<p>◆Recommended temperature profile of reflow soldering Figure shows recommended temperature profile of reflow soldering in the case of lead-free solder alloy Sn3.0Ag0.5Cu. Suitable condition for solder heating is differed depending on composition and manufacturing method. Please contact to solder manufacturer for the details.</p> <p>Temperature (°C)</p> <p>Ambient temperature rise slope : 1~4°C/sec.</p> <p>Pre-Heating 150~180°C</p> <p>50~110sec.</p> <p>30~50sec.</p> <p>Temperature in heat condition : 230°C min. 50sec. max. 260°C min. 10sec. max.</p> <p>Ambient temperature cool slope : 1~4°C/sec.</p> <p>10sec.</p>